

8.2 - TUERCA UNION DE ALUMINIO. PARA AREAS PELIGROSAS. SERIE TU - PC. CON RECUBRIMIENTO EXTERIOR DE PVC E INTERIOR DE URETANO PURPURA.

8.2 - ALUMINUM CONDUIT UNION. FOR HAZARDOUS LOCATIONS. TU - PC SERIES. PVC COATING AND PURPLE URETHANE INNER COATING.

Hoja: 1 / 2
Page:

FICHA TECNICA / TECHNICAL DATA

007 - RW - 236

APLICACIONES

- Utilizados para unir tubo conduit RIGIDO y accesorios, permitiendo desmontar sin desenroscar el tubo.

CONSTRUCCION

- Aluminio libre de cobre inyectado a presión (diecast).
- Ranuras concéntricas de empare para asegurar un sellado perfecto.
- Rosca NPT para conduit RIGIDO.
- Roscas de precisión para garantizar continuidad en el aterrizaje.
- A prueba de ambientes corrosivos.
- Recubrimiento PVC: 40 mil. mínimo.
- Uretano PURPURA: 2 mil. mínimo.
- Mangas en las entradas para un sellado hermético.

Clase I, Div. 1 & 2, grupos C, D.

Clase II, Div. 1, grupos E, F, G.

Clase II, Div. 2, grupos F, G.

Clase III.

NEMA 4,4X, 7 C D, 9 E F G.

- Fabricación en base a: UL 886, UL 1203
CAN/CSA - C22.2 No. 30

APPLICATIONS

- Conduit unions are used to connect RIGID conduit to conduit fittings, allowing to disassembly it, without turning the conduit.

CONSTRUCTION

- Diecast copper free aluminum.
- Matching grooves to have a perfect seal.
- NPT threaded for RIGID conduit.
- Precision threads to assure ground continuity.
- For use in corrosive environments.
- PVC coating: 40 mil. min.
- PURPLE Urethane: 2 mil. min.
- Pressure sealing sleeves on conduit openings.

Class I, Div. 1 & 2, groups C, D.

Class II, Div. 1, groups E, F, G.

Class II, Div. 2, groups F, G.

Class III.

NEMA 4,4X, 7 C D, 9 E F G.

- Manufactured in compliance with: UL 886, UL 1203
CAN/CSA - C22.2 No. 30

Para dimensiones:
Ver Ficha Tecnica 007-RW-263
For dimensions:
See Technical Data 007-RW-263

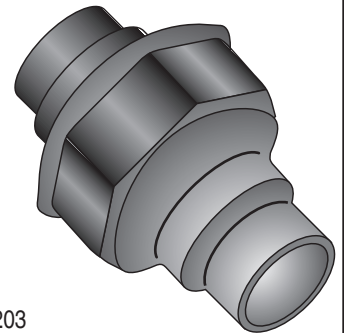

TUERCA UNION HEMBRA PVC / PVC FEMALE CONDUIT UNION

USAR No. DE CODIGO PARA HACER PEDIDOS / TO ORDER USE CODE NUMBER

Figura Figure	Catálogo Catalog	Código Code	Medida Nominal Size		Peso x 100 pzas. Weight x 100 pcs.		Unit Ctn. Pzas. Pcs.	Ship Ctn. Pzas. Pcs.	Std. Pkg. Pzas. Pcs.
			mm	inch	kg	Lb			
	TU-2992-PC	12.30.3062.PC	12.7	1/2	12.35	27.23			70
	TU-2993-PC	12.30.3063.PC	19.0	3/4	15.0	33.0			60
	TU-2994-PC	12.30.3064.PC	25.4	1	19.6	43			44
	TU-2995-PC	12.30.3065.PC	31.7	1 1/4	32.0	70			21
	TU-2996-PC	12.30.3066.PC	38.1	1 1/2	35.0	77			18
	TU-2997-PC	12.30.3067.PC.	50.8	2	56.85	125.3			14

TUERCA UNION MACHO - HEMBRA PVC / PVC MALE - FEMALE CONDUIT UNION

USAR No. DE CODIGO PARA HACER PEDIDOS / TO ORDER USE CODE NUMBER

Figura Figure	Catálogo Catalog	Código Code	Medida Nominal Size		Peso x 100 pzas. Weight x 100 pcs.		Unit Ctn. Pzas. Pcs.	Ship Ctn. Pzas. Pcs.	Std. Pkg. Pzas. Pcs.
			mm	inch	kg	Lb			
	TU-2992-NP	12.30.3155.NP	12.7	1/2					
	TU-2993-NP	12.30.3156.NP	19.0	3/4					60
	TU-2994-NP	12.30.3157.NP	25.4	1					44
	TU-2995-NP	12.30.3158.NP	31.7	1 1/4					
	TU-2996-NP	12.30.3159.NP	38.1	1 1/2	49.6				15
	TU-2997-NP	12.30.3160.NP	50.8	2	80.7				8

Especificaciones sujetas a cambio sin previo aviso. Specifications are subject to change without notice.

RAWELT, S.A. de C.V.



Una División del Grupo REVUELTA

**8.2 - TUERCA UNION DE ALUMINIO. PARA AREAS PELIGROSAS. SERIE TU - PC.
CON RECUBRIMIENTO EXTERIOR DE PVC E INTERIOR DE URETANO PURPURA.**

**8.2 - ALUMINUM CONDUIT UNION. FOR HAZARDOUS LOCATIONS. TU - PC SERIES.
PVC COATING AND PURPLE URETHANE INNER COATING.**

Hoja: 2 / 2
Page:

FICHA TECNICA / TECHNICAL DATA

007 - RW - 236

NIPLES / NIPPLES

USAR No. DE CODIGO PARA HACER PEDIDOS / TO ORDER USE CODE NUMBER

Figura Figure	Catálogo Catalog	Código Code	Medida nominal Hub size		Peso x 100 pzas. Weight x 100 pcs.		Pqt. Unit. Pzas. Pcs.	Unit Ctn. Pzas. Pcs.	Ship Ctn. Pzas. Pcs.	Std. Pkg. Pzas. Pcs.
			mm	inch.	kg	Lb				
			 NIPLE	NI-13-EX	04.28.3236.EX	12.7				
NI-19-EX	04.28.3237.EX	19.0		3/4			25			
NI-25-EX	04.28.3238.EX	25.4		1			25			
NI-32-EX	04.28.3239.EX	31.7		1 1/4			10			
NI-38-EX	04.28.3240.EX	38.1		1 1/2			10			
NI-50-EX	04.28.3241.EX	50.8		2			10			

Certificaciones / Compliances:  Expediente/File No. E198859

Certificaciones / Compliances:  Expediente/File No. 1187341

Class I groups A, B, C and D; **Class II** groups E, F and G; **Class III**
TU-2992, TU-2993

Class I groups B, C and D; **Class II** groups E, F and G; **Class III**
TU-2997

Class I groups C and D; **Class II** groups E, F and G; **Class III**
TU-2996

RAWELT, S.A. de C.V.

 **RAWELT**® INYECTADOS
Una División del Grupo  **REVUELTA**

**8.2 - TUERCA UNION DE ALUMINIO. PARA AREAS PELIGROSAS. SERIE TU - PC.
CON RECUBRIMIENTO EXTERIOR DE PVC E INTERIOR DE URETANO PURPURA.**

**8.2 - ALUMINUM CONDUIT UNION. FOR HAZARDOUS LOCATIONS. TU - PC SERIES.
PVC COATING AND PURPLE URETHANE INNER COATING.**

Hoja: 1 / 1
Page:

FICHA TECNICA / TECHNICAL DATA

007-RW-263

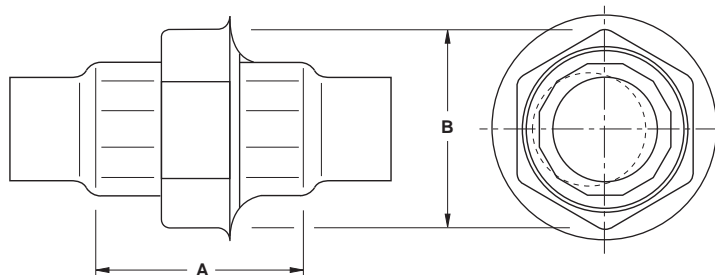

TUERCA UNION HEMBRA PVC				PVC FEMALE CONDUIT UNION			
Catalogo Catalog	Código Code	Medida Nominal Size		Longitud sin mangas Length w/out sleeves		Medida ext. Máx. Max. Outside size	
				A		B	
		mm	Inch.	mm	Inch.	mm	Inch.
TU-2992-PC	12.28.3062.PC	12.7	1/2	44	1.73	54	2.13
TU-2993-PC	12.28.3063.PC	19.0	3/4	44	1.73	60	2.36
TU-2994-PC	12.28.3064.PC	25.4	1	52	2.04	65	2.56
TU-2995-PC	12.28.3065.PC	31.7	1 1/4	58	2.20	80	3.15
TU-2996-PC	12.28.3066.PC	38.1	1 1/2	61	2.38	86	3.39
TU-2997-PC	12.28.3067.PC	50.8	2	70	2.77	106	4.17

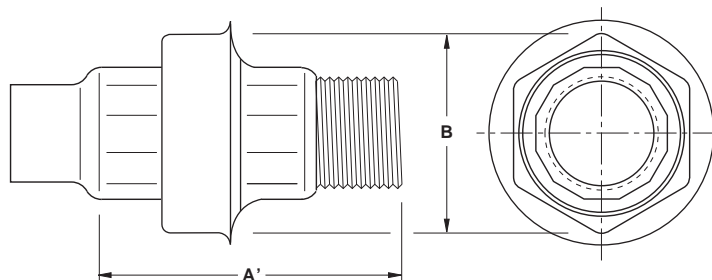

TUERCA UNION MACHO-HEMBRA PVC / PVC MALE-FEMALE CONDUIT UNION							
Catalogo Catalog	Código Code	Medida Nominal Size		Longitud sin mangas Length w/out sleeves		Medida ext. Máx. Max. Outside size	
				A'		B	
		mm	Inch.	mm	Inch.	mm	Inch.
TU-2992-NP	12.30.3155.NP	12.7	1/2	77	3.03	54	2.13
TU-2993-NP	12.30.3156.NP	19.0	3/4	77	3.03	60	2.36
TU-2994-NP	12.30.3157.NP	25.4	1	91	3.58	65	2.56
TU-2995-NP	12.30.3158.NP	31.7	1 1/4	99	3.90	80	3.15
TU-2996-NP	12.30.3159.NP	38.1	1 1/2	106	4.17	86	3.39
TU-2997-NP	12.30.3160.NP	50.8	2	118	4.65	106	4.17

RAWELT, S.A. de C.V.

Una División del Grupo **REVUELTA**



Cotización/Quotation Plazo de embarque* / Shipment exw*

Pedido No./Purchase order :

Our ref.:

Fecha/Date: Vendedor/Salesman: No.

Facturar a/Invoice to: RFC.

Ordenado por/Ordered by: Tel. () Fax ()

Dirección/Address:

C.P./Zip. Lugar/City/Country:

Consignar a/Ship to:

Embarcar: Camión x Cobrar Pagado Paquete

Cond. de Pago/Terms:

Cond. de Venta/Sale conditions: L.P.:

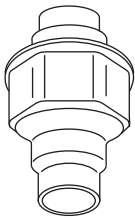
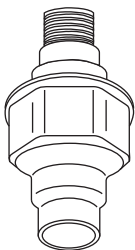
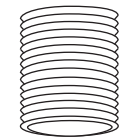
8.2 - SERIE TU-PC. TUERCA UNION DE ALUMINIO. HEMBRA / ALUMINUM FEMALE CONDUIT UNION CON RECUBRIMIENTO DE PVC. WITH PVC COATING.								
Figura Figure	Código Code	Medida nominal Hub size		Pqt. Unit. Pzas. Pcs.	Unit. Ctn. Pzas. Pcs.	Ship Ctn. Pzas. Pcs.	Std. Pkg. Pzas. Pcs.	Cantidad Qty.
		mm	inch					
	12.30.3062.PC	12.7	1/2				70	
	12.30.3063.PC	19.0	3/4				60	
	12.30.3064.PC	25.4	1				44	
	12.30.3065.PC	31.7	1 1/4				21	
	12.30.3066.PC	38.1	1 1/2				18	
	12.30.3067.PC	50.8	2				14	
8.2 - SERIE TU-PC. TUERCA UNION DE ALUMINIO. MACHO-HEMBRA / ALUMINUM MALE-FEMALE CONDUIT UNION CON RECUBRIMIENTO DE PVC. WITH PVC COATING.								
Figura Figure	Código Code	Medida nominal Hub size		Pqt. Unit. Pzas. Pcs.	Unit. Ctn. Pzas. Pcs.	Ship Ctn. Pzas. Pcs.	Std. Pkg. Pzas. Pcs.	Cantidad Qty.
		mm	inch					
	12.30.3155.NP	12.7	1/2					
	12.30.3156.NP	19.0	3/4				60	
	12.30.3157.NP	25.4	1				44	
	12.30.3158.NP	31.7	1 1/4					
	12.30.3159.NP	38.1	1 1/2				15	
	12.30.3160.NP	50.8	2				8	
	04.28.3236.EX	12.7	1/2	25				
	04.28.3237.EX	19.0	3/4	25				
	04.28.3238.EX	25.4	1	25				
	04.28.3239.EX	31.7	1 1/4	10				
	04.28.3240.EX	38.1	1 1/2	10				
	04.28.3241.EX	50.8	2	10				

• Antes de fincar el pedido en firme, favor de confirmar con fábrica el plazo de embarque definitivo.

• Before place your order, please confirm with RAWELT definitive date of shipment.

Producción Almacén Embarques Control Expediente

Ciente

Ing. de Ventas